

ANALYSIS OF SPEECH ENHANCEMENT USING SIGNAL TO NOISE RATIO ESTIMATION

¹S SANTHOSH, ²K VIKRAM, ³G ANJANEYULU

^{1,2,3}Assistant professor, ECE Department, St.Martin's Engineering College

ABSTRACT

When abrupt changes in the noise level occur, the current algorithms are not successful. The new sound recognition algorithm is a possibility in this speech enhancement study to address the shortcomings of unventurous methods. The reliable and potential methods are predicted for the noise signal. To determine the improved SNR value, calculate the SNR (signal-to-noise ratio), input signal plus added noise and the filtered signal. We get the better voice signal with decreased noise using filters. The target speaker is competent to achieve substantial improvement in the predicted speech quality (SQ) and speech clarity, and the SNRs are explicitly designed to override all speakers, noise types and SNRs. A noisy sound of an untrained voice is finally processed, we compare the proposed algorithm to other algorithms for improving voice. All the components of the proposed algorithm contributed to their mutual meaning. were analyzed.

1. INTRODUCTION

Introduction to Speech Enhancement

Language is the most important way for people to communicate. With technical advancements, communication is omnipresent and is becoming reality in mobile communications. Mobile technology is bringing new technical advances each day and can be widely used, including robustness to acoustic background noise. In noisy environments, such as vehicles, coffee shops, railway stations, etc., speech enhancements are being made a bridge for mobile telephone services, to make noise management systems more effective and secure. Algorithms for enhanced speech efficiency and signal intelligibility are used to enhance speaker efficiency. In order to enhance the expression, an audio signal processing technique increases the intelligibility and perceived efficiency of a degraded speech signal [1]. The improvement of speech aims at enhancing the voice signal damaged by unfavorable signals, I. H. Signal of noise which may be in any way available: background vibration, vibration, traffic noise. The series, etc. The increasing use of voice communications systems over the years is followed by a wide variety of applications.

In multi-mouth piece voice improvement ponders three kinds of clamour fields are examined: 1) an indistinguishable disturbance caused by the hardware of the recipients; 2) intelligible clamor generated by a single, well defined directional clamor source which describes a high relation between the sign of disturbance; and 3), diffuse clamor representation of an uncorrelated disturbing power distribution sign.

The language around us, for instance if the person wants to use his cell phone in a public place, is being degraded. A lot of noise must be filtered out behind the scenes so that the customer listens to what the caller is talking to him on the other end. There is still some noise in areas such as a busy street or house as you try to converse with others. The use of an automobile device often intercepts intrusion and noise from the car or other vehicle occupants [5]. In the preparation of speeches, speech signals and the methods for treating these signs are studied. In general, the sign is portrayed in an advanced portrait with the intention that the planning of the discourse can be regarded as an exceptional instance of computerized sign handling connected with the speech signal.

Different types of speech deterioration

The loss of the speech signal[7] is caused by many causes. Speech at any point before hitting the final audience can be distorted by noise. The following can be defined as approximately the different forms of which the language can be downgraded.

At the source of the speech

In a noisy environment, background noise is added to the signal. Noise such as the aircraft's engine, a moving car or other ambient noise. The sound concerned is the multiplication tone of which the tone is folded by the voice signal [7].

During transmission of the signal

In fact, unsophisticated communication activities add up to the discourse signal when transmitting discourse on the web. The sign may also be entered when adjusting details before transmission or in the middle of voice replay at the end of the audience[7].

Noise at the end of the receiver

When the speech source is in a quiet environment, the end user may reside in a noisy environment that often triggers time between the ears, because the voice quality obviously decreases. In this case, therefore, language development is also important [7].

Speech frequency

One of the sound frequencies used for voice transmission is a speech recurrence (VF) or speech unit. The accessible speech recurrence tape varies in contact between approximately 300 Hz and 3400 Hz. And somewhere between the 300 and 3000 Hz range, the ultra-low recurrence strip of the electromagnetic spectrum is often called speech recurrence. Electromagnetic vitality that speaks of the baseband's acoustic vitality. The transmission speeds of a single voice recurrence channel are 4 kHz on a regular basis for monitor classes, which require the use of an 8 kHz test recurrence, as the reason for the Beat Code Balance Mechanism used allows the PSTN to be computerized. Hypothesis inspection: The test recurrence (8 kHz) must be, in any case, twice as high as the discourse recurrence (4 kHz) in order to efficiently rework the discourse signal[3].

2. LITERATURE REVIEW

M. A. Abd El-Fattah[1] proposed a flexible use of the Wiener Filter for better discourse. The suggested flexible channel from Wiener uses observable information (Medium and fluctuation) to adjust the channel exchange capacity for the example. The flexibility of Wiener channel is achieved not in recurrent vacuum, but on the world. The strategy suggested is contrasted with the traditional Viennese channel with ghostly methods of subtraction and tests indicate their prevalence. This approach depends on the essence of the message. The presentation of such strategies.

S. China Venkatswarlu [8] has put forward a Wiener dependent device that distinguishes itself in a noisy perception from the awareness of the proximity of the symbol. Two different estimators from earlier are tried and tested for the sign's chaos ratio. This technique is important because of its low level of complexity. He shows the use of the Vienna channel

for a speech signal in this article. After the evaluation of the base cry the Viennese canal is rather basic and possible. The third impediment in ghostly techniques of subtraction is to manage the speech signal in the housings, and if you switch from one housing to the next one, discontinuities can be avoided. The decrease in congestion is an important problem of upgrading speech systems in communication with no hands.

In the convergence of the decision-directed method (DD) with a flexible transient division, Richard C. Hendriks[2] demonstrated a technique for improving approximations. Objective and abstract tests show a remarkable improvement over the existing DD method by the proposed technique. The leisure discovery often indicates a decline in the remaining temporary chaos. The creator showed how the above estimation can be improved and how the shown DD method can be improved. Finally, the DD method is combined with a flexible measurement of loud speech transient division, which has been familiar with enhancing discourse upgrade depending on the highest likelihood.

A book was written by P.C loizou [3] on theories and routines for linguistic improvements, which established speech signals, such as voice signal era, voice signal degradation, various measurements to improve the discourse signals and SNR, as well as its importance for a vocal signal.

The double-amplifier discourse upgrade method for the SNR estimate was proposed by NimaYousefian[4] in cases where two close-up receivers are available. The method uses lucidity between the target and clamor flag as a model to minimize turbulence and can primarily be applied to devices with near mouths, with an exceptional relation with the clamor recognized by the sensors. The method proposed is hard to carry out and involves no method of clamor measurements. This also offers the ability to deal with various impedance sources that may occur in various azimuths. With the aid of coherence checks and a solid beamforming measurement, standard members of the audience were tested for the proposed measurement.

3. METHODOLOGY

Algorithms Implementation in the MATLAB

A multi-world view of numerical concept and fourth-age programming language is a MATLAB (Vector Laboratory). MATLAB, an proprietary programming language developed by MathWorks, allows network controls and the resources and knowledge to be

mapped, calculations are clearly made, UIs are created and projects in various dialects, including C, C++, C #, Java, Fortran, and Python. MATLAB bolsters build graphical UI (GUI) applications. MATLAB provides GUIDE for interactive Application planning (Application enhancement condition).

Record and Play Sound using MATLAB

```
a=audiorecorder(8000,8,1); %where 8000 is the
sampling frequency,8 is thenumber of bits and 1 is
the channel ID,these are the parameters at which
author wantto record the sound that can be varied
easily% record(a,5);%record command is usedto
record the sound for specific time t=5 sec which can
be changed as per therequirement or can simply
record sound without specifying the timeb=
getaudiodata(a);
play(b);%another command i.e., sound(b) can also be
used to play the recordedsound%
```

```
plot(b);%graph of sound can be plotted by using plot
command%
%noise cancellation can be done by adding the filter
command which has been doneusing butter filter %
[B,A]=butter(2,0.01);
subplot(211),plot(d);
subplot(212),plot(filter(B,A,d));
```

Speech Enhancement System using LABVIEW

LabVIEW is a programming situation where you create programs using a graphe documentation (associating the useful hubs by wiring from which information is flows) that contrast with typical programming dialects such as C, C++ or Java where you are scheduling with material. The software is a programming situation where the Laboratory is a virtual instrument engineering workbench. It is an intuitive program development and execution system for people who need to program as an aspect of their careers, similar to researchers and designers.

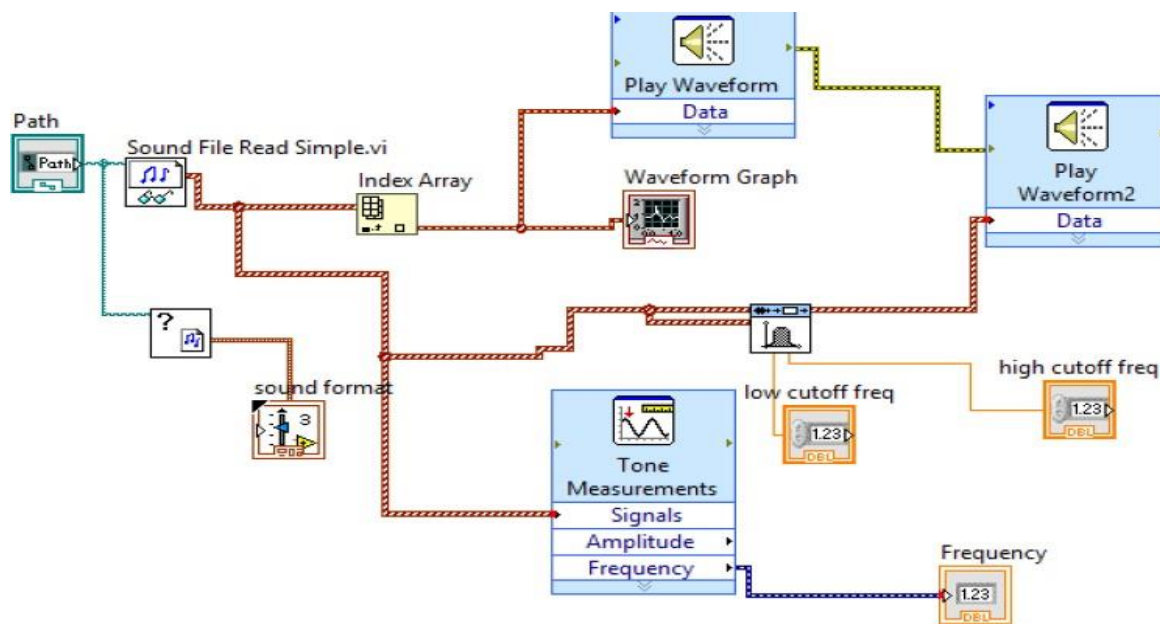

Fig. 1: Block Diagram of Speech Enhancement Using LabView (Band Pass Filter)

Speech Enhancement in LABVIEW using Adaptive Filters

The figure demonstrates the discourse development of the .wav document using the symbols shown above in the lab view. System for Dialogue Enhancement in LabView. The entire structure has been split into two sections. The first front of the panel which includes a sign of control and the second square which involves control of the whole panel. The following backboard (square outline).

Measure Speech Signal

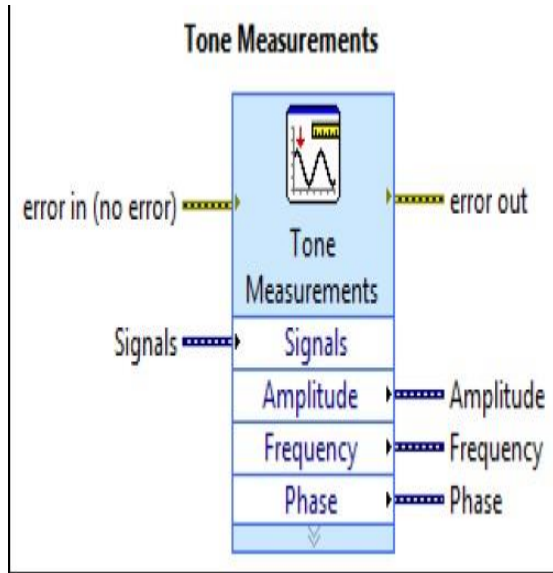

Fig. 2: Tone Measurement Bandpass Filter

Upgrade and react signals by adding a band pass channel. Sign in and raise the signal knowledge in contributions so you can agree on the polymorphic occasion to use or pick the example physically. The band passing channel is an unbounded elliptical drive reaction channel (IIR) with no point.

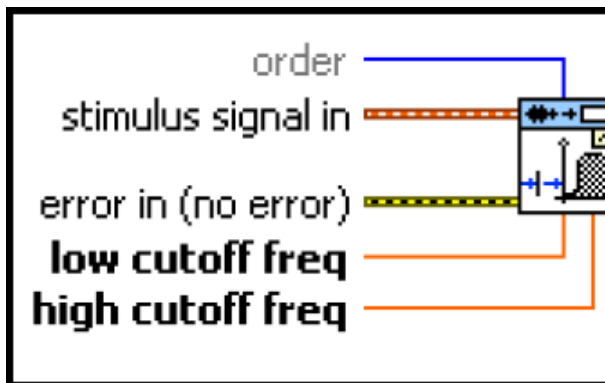

Fig. 3: Shows Band Pass Filter

The framework determines the request for the channel. The norm is 6. The request value must be higher than 0. Expanded device knowledge provides a stronger channel team. The low profile off recurrence shows the band move channel's low profile off recurrence. The recurrence cut-off shall be half the test limit. The high-cut recurrence of the band pass channel shows the deeply cut recurrence. The cut-off repetition must not necessarily be half the examination rate and more common than the cut-off repetition.

4. RESULT ANALYSIS

Matlab Result Analysis

The graph displays the quiet, noisy and improved speech signals. The quiet signal is free of errors of

any sort. The noisy signal is the signal that has been distorted by the noise that reduces the quality / intelligibility of the signal, rendering the human listeners unable to perceive it. This signal increases the SNR's clarity / intelligibility in the noisy voice. It boosts its efficiency and intelligibility.

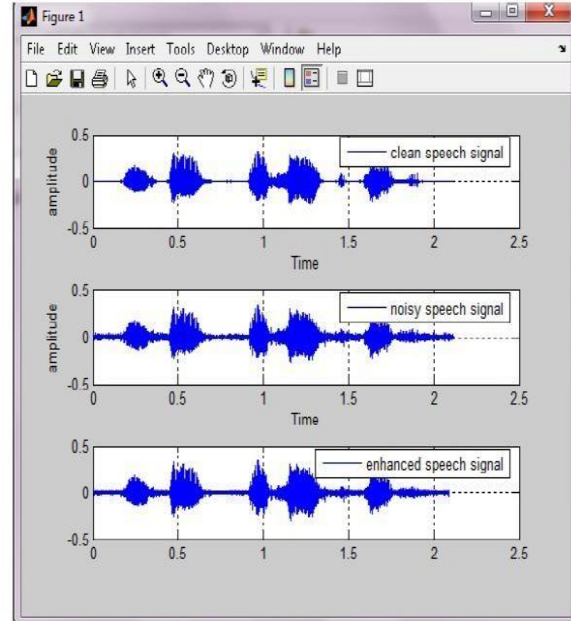

Figure 4: Plots of Speech Signals Clean (Top), Noisy (Middle) and Enhanced (Bottom)

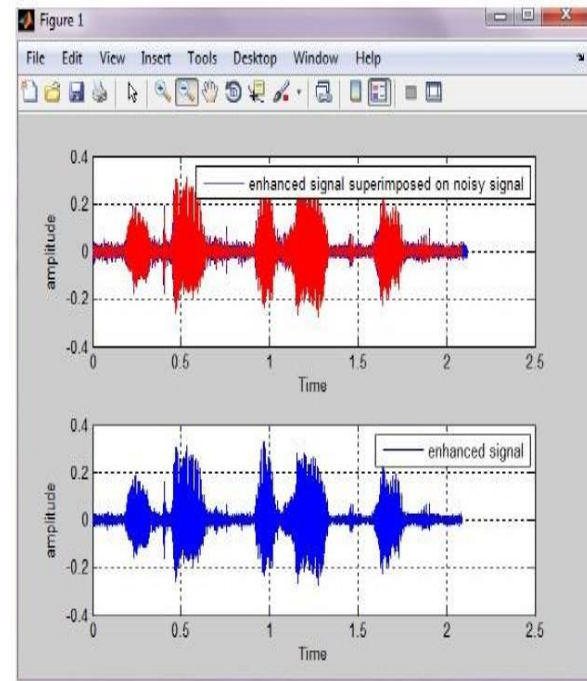

Figure 5: Plot of Enhanced Signal Superimposed on Noisy Signal

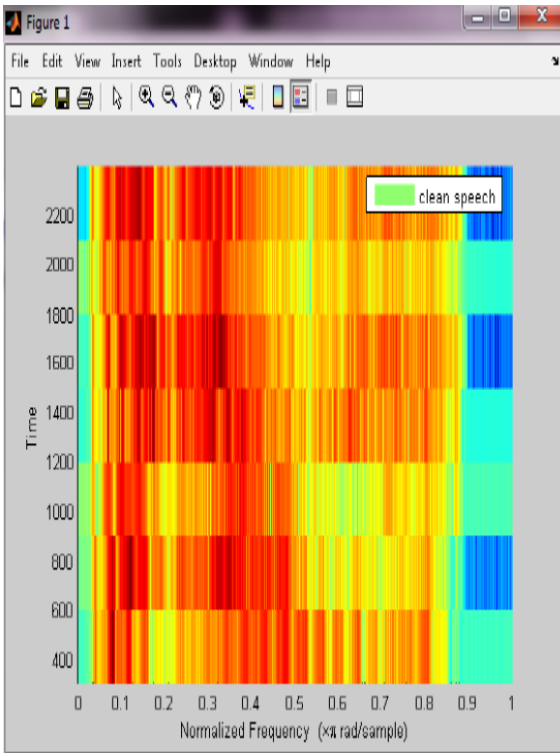

Figure 6: Plot Spectrogram of clean speech signal

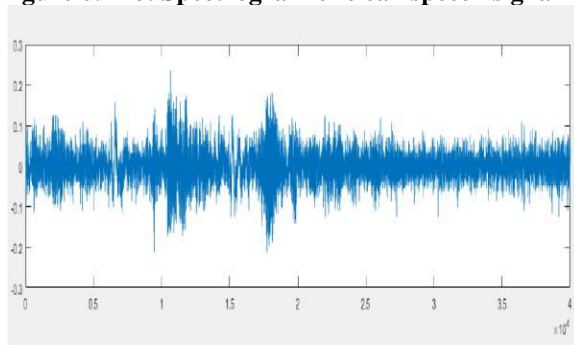

Fig. 7: Recorded Sound before Adding Filter

CONCLUSION

Specific discourse update is a nuanced, interdisciplinary subject focused on stochastic theory of control (framework recognizable evidence, ideal sifting), the misuse of material science (acoustic science and specialist building), computerized sign planning, numerical arithmetic, software engineering (effective computing structure), and different orders. This count has been done and tested and shows that parallel figure strategies will benefit from speech update calculations. The basic preferential position in this theory is to use Kalman's scrub against disarthy subtraction and isolation of Wiener from the other false premises of the debate and noise properties

imposed by the last two strategies. This is usually the use of Kalman sifting to adaptably separate the knowledge sign to identify the authentic fixed spaces of the expression. In fact, this analysis can be achieved for a single, multidimensional therapeutic signal. In Matlab and LabView it is possible to conduct other calculations in the ongoing.

REFERENCES

- [1] M. A. Abd El-Fattah, M. I. Dessouky, S. M. Diaband and F. E. Abd El-smile "Speech enhancement using an adaptive wiener filtering approach", ProgressIn Electromagnetics Research', vol.4,no.3 pp.167–184, 2008.
- [2] R.C.Hendriks, R.Heusdens and J.Jensen "Improved Decision Directed approach for speech enhancement using an adaptive time segmentation" Interspeech Conference, vol.14 , no.6, pp. 2101-2104, 2005.
- [3] P. C. Loizou, Speech Enhancement: Theory and Practice. New York: CRC,2007.
- [4] N. Yousefian and P. C.loizou "A dual microphone speech enhancement algorithm based on the coherence function" *IEEE Transactions, Audio, Speech, and Language Processing*, vol.21, no. 1, pp. 599-609, 2012.
- [5] N. Madhu, A. Spriet, S. Janson, R.Koning and J. Wouters "The potential for speech intelligibility improvement using the ideal binary mask and the ideal wiener filter in single channel noise reduction system" *IEEE Transactions, Audio, Speech, Language Processing*, vol.21, no.1, pp. 63 -72,2013.
- [6] C. Plapous, C. Marro and P. Scalart "Improved signal-to-noise ratio estimation for speech enhancement" *IEEE Transactions, Audio, Speech, Language Processing*, vol. no 1., pp. 1-11,2005.
- [7] S.China Venkateswarlu, A.karthik "Performance on Speech Enhancement Objective Quality Measures Using Hybrid Wavelet Thresholding" International Journal of Engineering and Advanced Technology publisher by Blue Eyes Intelligence Engineering & Sciences publication. vol.8,issue6.pp.35233533,2019.
- [8] L.R. Rabiner, and R.W. Schafer "Digital processing of speech signals" Pearson 2005.
- [9] Hu Y, Loizou P. "Subjective comparison and evaluation of speech enhancement algorithms". *Speech Commun.* 2007 Jul; 49(7): 588–601.
- [10] Lim J. "Evaluation of a correlation subtraction method for enhancing speech degraded by additive noise". *IEEE Trans. Acoust., Speech, Signal Proc.* 1978; vol. 37(no. 6):471–472.